



Radcliffe
Glass & Windows
The home of brighter living



Legacy

PVCu Sliding Sash Windows



Period Style

The **Legacy** PVCu sliding sash windows carry all the beauty of a traditional design, coupled with all the benefits of modern materials that enable us to offer a cost effective, low maintenance window that doesn't compromise on aesthetics. From near-invisible joints, the elegance of the run-through sash horn to the curvy ovolo frame shape, these are just a handful of the many clever details that work together to create the most graceful and advanced sash window on the market.

With the increase of PVCu sliding sash windows being specified in premium developments, new design options and a bespoke colour-bonding service have been introduced, providing homeowners with a plethora of choice to create the perfect timber alternative solution that doesn't break the bank.



Contents

The Finer Details	Page 4
Slide & Tilt Facility	Page 7
Thermal Efficiency	Page 8
Planning & Conservation	Page 10
Quality & Compliance	Page 11
Peace of mind	Page 12
Hardware	Page 13
Colour Options	Page 14
Glass	Page 15
Styles & Shapes	Page 16
Technical Info	Page 19

The Finer Details

With our **Legacy** sash windows, you can respect the traditions, admire the woodworker's art, and enjoy modern advances that can make your home warm and secure. From a terraced house to a stately home, our sash windows can help ensure that your property retains its character and charm. You can choose from a wide range of styles, features, and hardware options to complement your home.



TRADITIONAL SASH HORNS

Enhance your window by opting for our premium sash horns. The run-through horn utilises mechanical joints rather than welded to allow the horn to be a continuous part of the sash giving the window a more authentic overall look.

DEEP BOTTOM RAIL

Choose a deep bottom rail if you want your sliding sash windows to look as close to the original timber version as possible. The fully mechanical deep bottom rail convincingly mimics the bottom sash of timber windows from the Victorian era and looks great with run-through sash horns.





WEATHER BAR

The sash window boasts an optional ovolo shaped weather bar, which is the latest of our heritage design features, developed to create an authentic sash window appearance.

ASTRAGAL BARS

Include a bar layout on your new sash windows for added character. Astragal bars are fixed onto the surface of the glass and are accompanied by back-to-back spacer bars inside the double-glazed unit to give the appearance of separate panes.





AUTHENTIC JOINTS

Replace your standard 45° mitre weld with either mechanical timber looking joints or seamless corner welds for an authentic finish that carefully disguises the PVCu aspects. Traditionally, a lot of time was spent handcrafting the original corner joints on timber sash windows and with our advanced machinery we can immitate these joints and get as close to the original as possible.



FULLY MECHANICAL JOINTS

The fully mechanical joints take authenticity to another level because the 45° PVCu welds on the frame and sash are replaced with 90° mechanical joints as found on traditional timber windows. Available on woodgrain windows only.



SEAMLESS WELDS

This revolutionary process disguises the external 45° corner welds with a flush mitre providing a far superior aesthetic finish. Available on woodgrain windows only and a minimum window size of 475mm wide x 900mm high.



Slide & Tilt Facility

Both the top and bottom sashes can slide up and down for ventilation. Our **Legacy** sash windows feature an easy clean tilt facility allowing you to clean the external side of your windows from inside the home. Please note, on windows with a woodgrain finish external and smooth finish internal we are not able to offer top sash tilt facility.

COLOUR-MATCHED TRICKLE VENTS

We offer two different vent solutions to comply with Document F of the building regulations. Both vents are colour-matched to match the aesthetics of our **Legacy** sash windows. Using the new exclusive modular vent will allow any of our welded windows over 775mm in width to comply with the new requirement to achieve 8000 EA airflow in a single window! If a certain rate of equivalent area (EA) is required, please let us know at the point of enquiry.



MODULAR VENT (2000 EA Per Module)



LINK VENT (2500/5000 EA Options)



Exceptional Thermal Efficiency

With fuel prices constantly on the rise, thermal performance is crucial. The window frames are built to last and resist the ever-changing conditions the British weather throws at them without losing their immaculate appearance.



'A' ENERGY RATED

The frames and sashes are multichambered, using the power of air as an insulator to stop warmth escaping. All our sash windows feature a 24mm insulated double-glazed glass unit with an argon gas insert as standard, which reduces the heat conductance between the panes. This happens because the gas is 6 times denser than air. The warm edge spacer bar incorporated into all units is made

from an extruded PVC material and has been specifically designed to reduce transference of heat between the panes of glass keeping more heat inside the property.

These thermal efficient elements work together to enable our **Legacy** sash windows to achieve an outstanding energy rating of 'A' and u-value of 1.4W/m²K as standard.

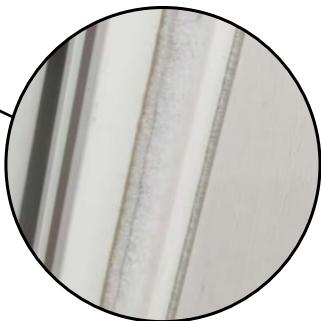

COLOUR-MATCHING WOOLPILE

The sash windows feature woolpile strips that provide an excellent seal against weather, air, and debris infiltration. We've paid attention to every detail and as something new we've introduced colour-matching woolpile to ensure that every single window is perfectly finished.

RECYCLABILITY

PVCu can be recycled over and over again, without any deterioration in performance. PVCu is an environmentally friendly choice as most PVCu windows will be recycled.

By choosing our sliding sash windows you can keep your home warm all year round, reduce your heating bills as well as helping the environment.



Planning & Conservation

As homeowners recognise not only the elegance of this traditional window style, but also its superior performance we're seeing a rise in PVCu sliding sash windows being specified in premium developments and historic homes alike.

We're often faced with projects that require special features to fit in with the unique character of a conservation area. In the past, many planners used to refuse applications to replace timber sashes with a PVCu alternative. However, the **Legacy** sash window has been designed to recreate tradition, which has led to an increasing number of approvals granted.

Quality & Compliance

As a reputable supplier of premium windows deserved by the British public, we look at the value of quality as an entity that requires constant attention and maintenance. Paramount quality and compliance continue to enhance our reputation of offering the best without compromising on the ever-important sash window aesthetics.

Our windows are tested annually for compliance to enhanced security standard PAS 24: 2016 as well as BS 6375 for weather performance. The manufacturing processes are also externally verified by ER Certification, to ensure the fabricator meets the required testing and manufacturing criteria to satisfy product standards and certification schemes.

BUILDING REGULATIONS

Building regulations are standards set in place by the Government to ensure that any building work is completed in a safe, efficient, and healthy manner. A window or door is classed as a 'controlled fitting', and any standards relating to this classification are required to be met.

Significant changes to the building regulations came into force on the 15th of June 2022 and have been the driving force in recent product developments such as colour-matched trickle vents and improved energy values.

If you're unsure, please ask your sales representative for assistance.





Peace of mind

Our sash windows deliver the most advanced levels of security without adding complex operation. They are practical and come with all the safety features you would expect from a modern window solution.



FIRE ESCAPE

If your window opening isn't large enough to comply with the requirements for means of escape, you have the option to request a fire escape facility. In order for a window to comply with the regulations covering means of escape, the window must provide an unobstructed opening of at least 0.33m².



PAS 24 SECURITY UPGRADE

Upgrade the security of your sliding sash windows by taking advantage of our comprehensive PAS 24:2016 security package. The enhancement includes two premium locks and top sash security blocks.

A PAS 24 upgrade is generally mandatory on new-build projects. Please note that the upgrade is not standard and must be requested as part of the window specification.

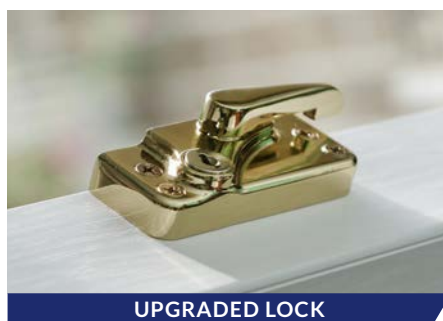

Hardware

LIFT HOOK

The lift hooks are usually fitted on the inside of the bottom sash to allow for easy opening.



D-HANDLE

Designed to be fitted to the underside of the top sash on the outside of the window to assist with the opening and closing of the window.



POLE EYE

Primarily designed to be fitted to the top rail of the top sash. The pole eye enables use of a pole with hook (not supplied) to operate any windows that are positioned too high to operate by hand.



LOCKING SYSTEM

Our locking system holds the sash window shut by fastening the mid-rails together. The locking system is available in two styles.



Standard



Heritage

SASH KNOB

Used to open and tilt the sashes for easy cleaning of the outside frame and glass from inside your home.



Standard



Heritage

TRAVEL RESTRICTORS

The travel restrictors limit the opening of the top and bottom sashes to approximately 100mm. They are primarily used as a safety feature in locations where opening restrictions are needed.



Hardware Colours

Our hardware is available in eight different finishes. Please note that our travel restrictors are only available in white, chrome, gold, and satin chrome.



White



Chrome



Satin Chrome



Bronze



Black



Gold



Graphite



Antique Black

Colour Options

Our sliding sash windows are available in 15 standard woodgrain colourways. By choosing a woodgrain foiled finish you can bring your windows to life with a glossy, realistic timber effect. You also have the option to add a true personalised touch to your new windows by picking a bespoke colour of your choice!

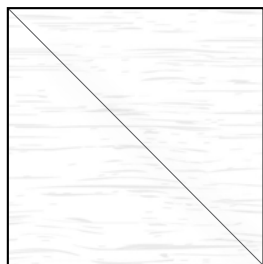

Ext: White Grain
Int: White Grain

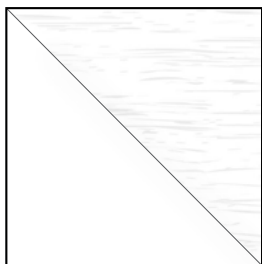

Ext: White Grain
Int: Smooth White

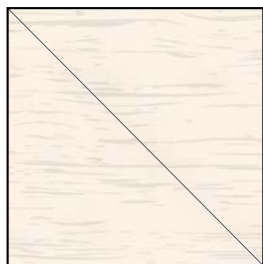

Ext: Cream Grain
Int: Cream Grain

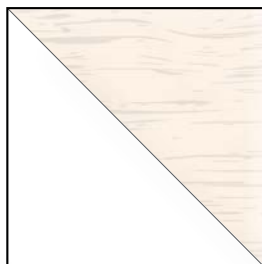

Ext: Cream Grain
Int: Smooth White

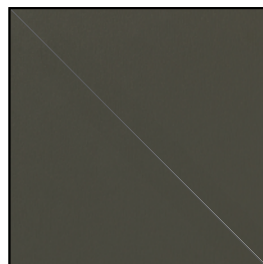

Ext: Grey Grain
Int: Grey Grain

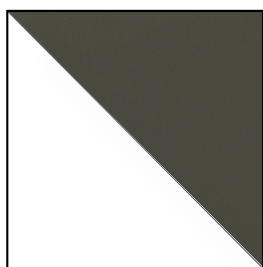

Ext: Grey Grain
Int: Smooth White

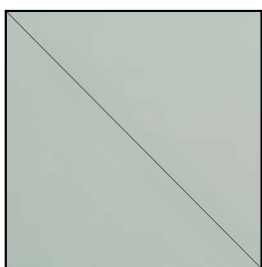

Ext: Agate Grey
Int: Agate Grey

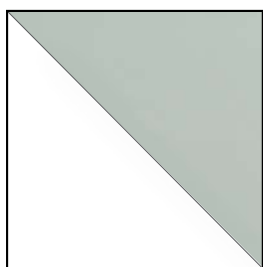

Ext: Agate Grey
Int: Smooth White

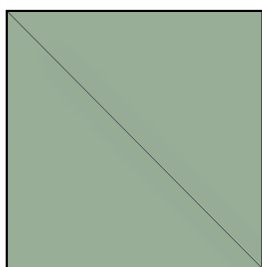

Ext: Chartwell Green
Int: Chartwell Green

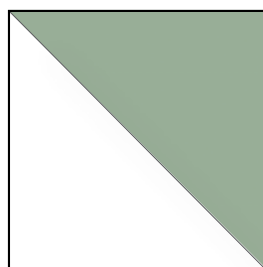

Ext: Chartwell Green
Int: Smooth White

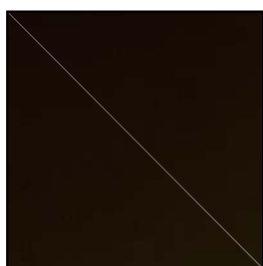

Ext: Black Ash
Int: Black Ash



Ext: Black Ash
Int: Smooth White

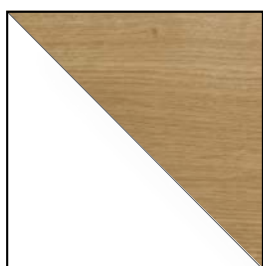

Ext: Irish Oak
Int: Smooth White



Ext: Golden Oak
Int: Smooth White



Ext: Rosewood
Int: Smooth White



Glass

STANDARD DOUBLE-GLAZING

The 24mm insulated glass units are double glazed with an argon gas insert as standard to reduce the heat conductance between the glass panes. All our sash windows feature 4mm clear glass on the outside and 4mm clear Low E glass on the inside, as well as a warm edge spacer bar.

LAMINATED GLASS

You have the option of upgrading to acoustic lamination for excellent noise reduction. This upgrade features two 3mm pieces of glass that are put together with a noise reducing interlayer.

OBSCURE GLASS

Our obscure glass range provides both substance and style. All patterns are classified according to their level of obscurity in relation to each other, with one being least obscure and five being most obscure.



Bark
Level 5



Contour
Level 3



Leaf
Level 3



Satin
Level 5



Stipple
Level 4



Westminster
Level 2

Styles and Shapes

Our **Legacy** sliding sash windows can be manufactured to a style to suit your home. Below are a few examples of the different bar layouts available. Our windows come with equal sized top and bottom sashes (50/50 split) as standard, however we can manufacture other split ratios at your request (minimum transom drop of 350mm).

Please get in touch if you require a bespoke style or bar layout.

BAR LAYOUTS

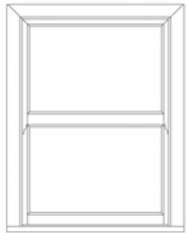

Non-bar

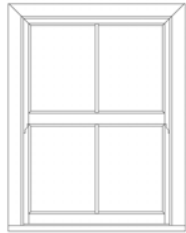

Centre Bar

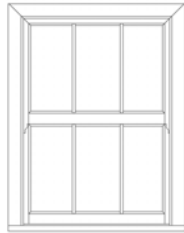

Three Light

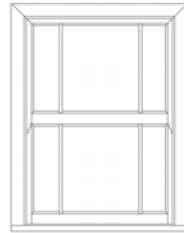

Offset Three Light

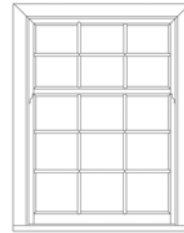

2/5 x 3/5

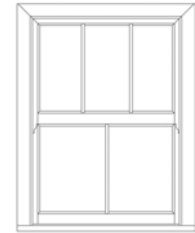

Assymmetric



Margin

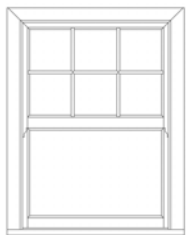

Half Georgian

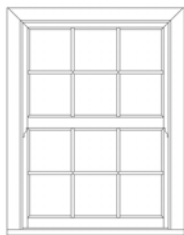

Georgian

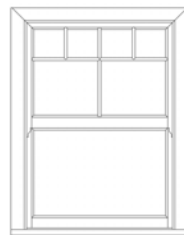

Georgian Variant



1/3 x 2/3

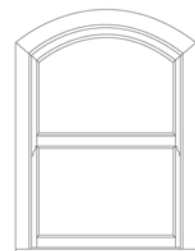

Swept Head*

ARCHED WINDOWS

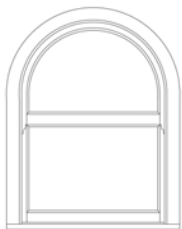

True Arch*

Our arched frames are made at a designated profile bending facility equipped with high tech equipment for precision. The most typical arched shape we see is a true arch, in which the top section has been beautifully curved. Please note a template may be required.

*Please note that on swept heads and arched frames the top sash will always be fixed. On arched windows, we can only offer black spacer bars.

COUPLED & BAY WINDOWS

Coupled and bay windows are both very popular for large openings as they open up the living space and bring in natural light.

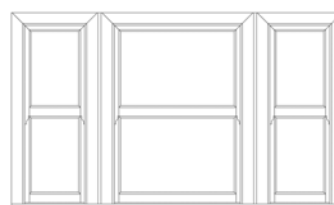

Coupled Windows

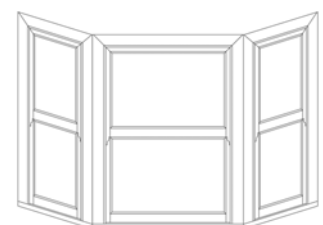

Bay Windows





Technical Information

Our technical information section covers manufacturing limitations and detailed technical drawings. To most people the technical drawings don't make much sense, so if you have any questions our product experts will be more than happy to explain in more detail.

TECHNICAL SPECIFICATIONS

Front-to-back Dimensions:	128mm
Sill Options:	150mm / 210mm
Glazed Unit:	24mm Double Glazed
U-Value:	1.4W/m²K
Air Tightness:	Class 3
Water Tightness:	5A
Wind Load:	Class 3A

MANUFACTURING LIMITATIONS

Minimum Width:	375mm
Minimum Height:	800mm
Maximum Width:	1500mm
Maximum Height:	2400mm

KEY PROFILE SECTIONS

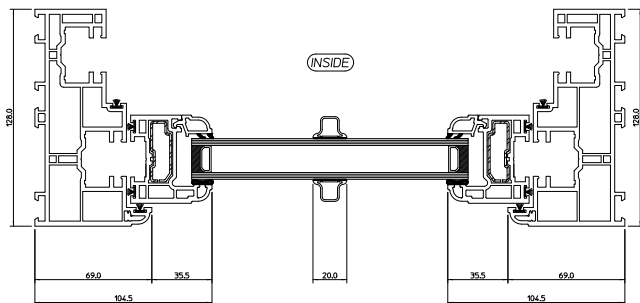

Bottom Sash Downwards View

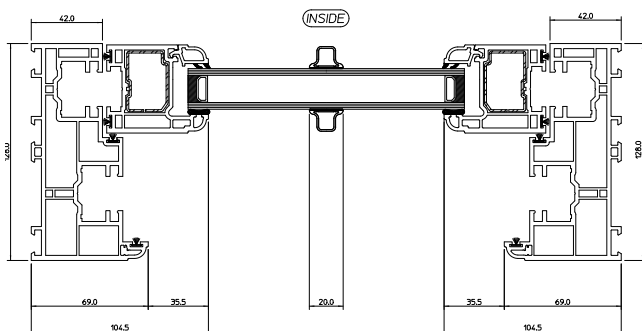

Top Sash Downwards View

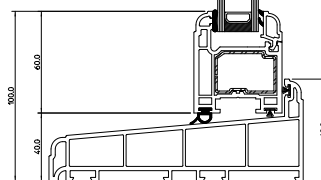
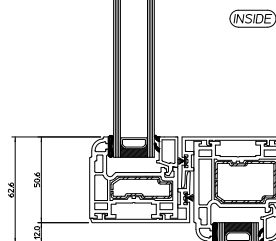
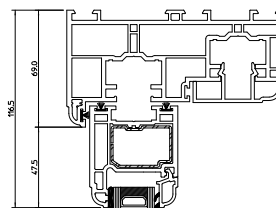

Sideways View - Standard Bottom Rail

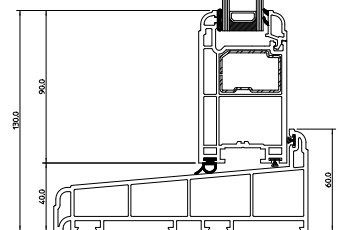
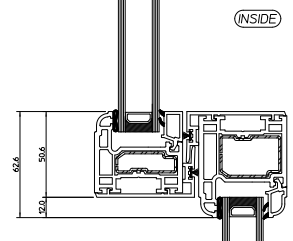
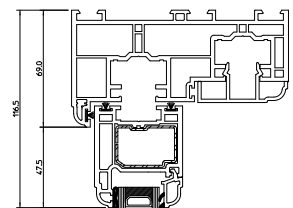

Sideways View - Deep Bottom Rail

The images, drawings and data shown in this brochure are for illustrative purposes only and are not binding in detail, colour, or specification. We reserve the right to make changes to the product specification as technical developments dictate and without prior notice.



Radcliffe
Glass & Windows

The home of brighter living

Head Office

3 Lodge Road, Manchester, M26 1AL

T: 0161 724 8501

www.radcliffeglassandwindows.co.uk